

KENTON

PRO-DCB *mk 3*

**professional bi-directional
MIDI to DCB converter**

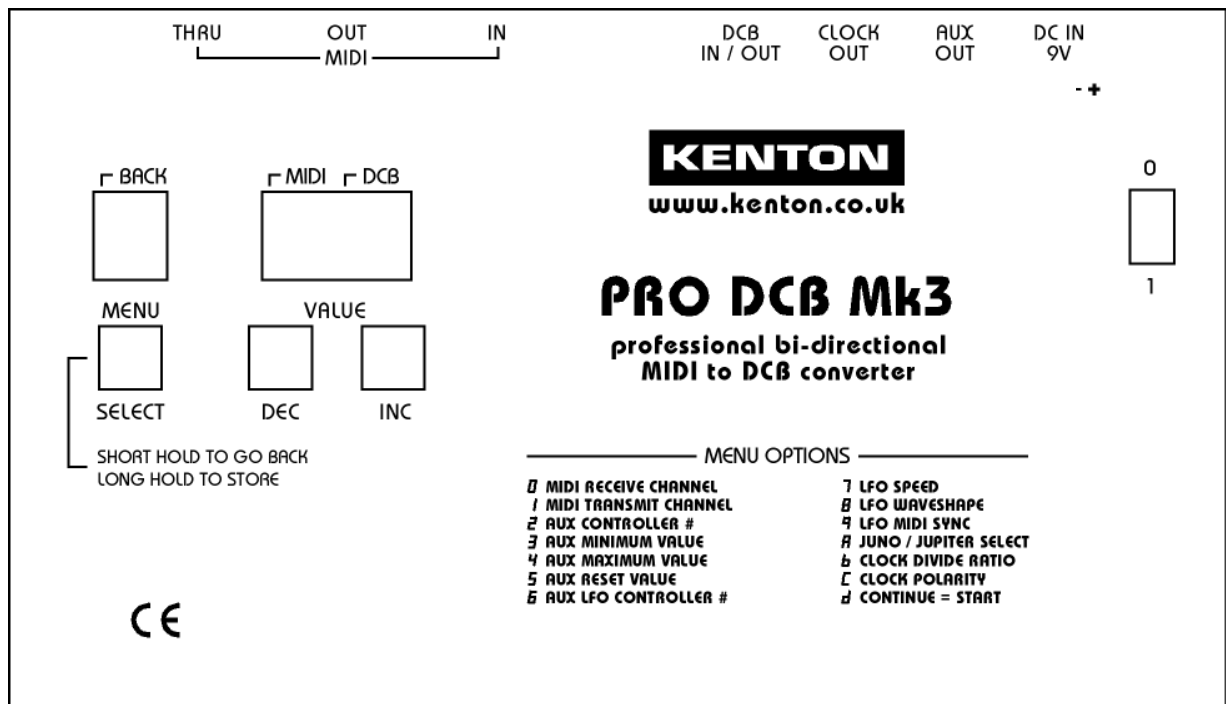

Operating manual

INTRODUCTION

The *PRO DCB mk3* is much more than just a MIDI to DCB converter, incorporating a built-in LFO as well as filter and arpeggio clock control. Please take some time to read through the entire manual to avoid any subsequent operational difficulties.

CONNECTIONS

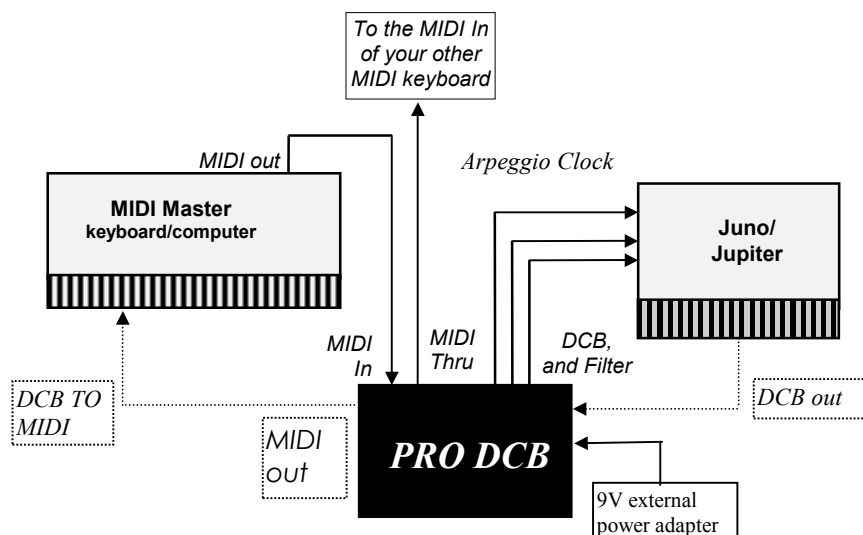

MIDI In

Plug your MIDI keyboard or sequencer's MIDI Out into here.

MIDI Out

Plug this into the MIDI In of your MIDI keyboard, when using the units DCB-MIDI capabilities

MIDI Thru

Plug this into the MIDI In of another piece of your MIDI equipment should it be necessary.

DCB

Plug this into your synth's input marked DCB. This transmits and receives DCB information.

AUX

Plug this into your synth's input marked VCF. This controls the filter cutoff via MIDI.

ARP CLOCK

Plug this into your synth's input marked ARP CLOCK, this controls the speed of the arpeggio clock, and syncs it to MIDI clock.

9V DC

Plug the supplied power adaptor into here. The converter is designed to use a 9V unregulated power adaptor, or can be used with up to a 12V regulated supply. The PRO-DCB must not share a power adaptor with any other device of any kind as this may damage your unit, and/or the other device.

EDITING THE PRO DCB

Switching On

When the *PRO DCB* is switched on, the words **KENTON PRO DCB** scroll across the display.

The Display

There are 3 digits on the 7-segment display. The 1st digit shows which parameter is ready for editing. The right-hand, 2nd & 3rd digits will then display what the value of the parameter is. There are also 3 red dots which you may see appear. The 1st dot when lit indicates the **SELECT** button is in reverse operation (see below), the middle dot when MIDI information is being received on the selected channel, and the 3rd dot will light when the unit receives DCB information (i.e. when it is being used in DCB-MIDI mode).

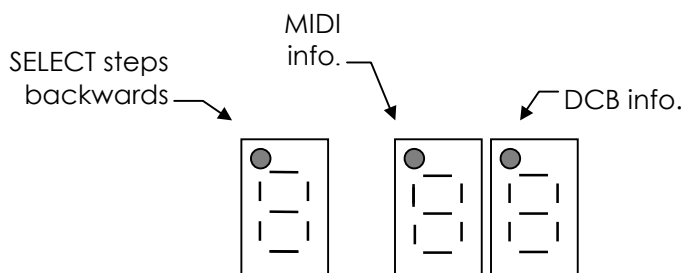

Stepping through parameters

Each parameter is accessed using the **SELECT** button. There are 14 parameters in the menu, listed in the next section 'Parameters'.

Press the **SELECT** button to get to the parameter in question, then use the **INC**rement (+) and **DEC**rement (-) buttons to edit the value.

If you press and hold the **SELECT** button for more than 1 second, you can step through the parameters in the opposite direction. A red LED dot will light up to indicate this. If the **SELECT** button is pressed and held for 1 second again, the direction will return to normal and the red LED dot will disappear.

Displaying values above 99

When displaying values from 0 to 99, you will see the digits as you would expect.

When displaying values above 99, the following format is used :-

a dash " - " at the bottom of the left-hand display = 100+

a dash " - " in the middle of the left-hand display = 110+

a dash " - " at the top of the left-hand display = 120+

No values above 127 are used.

Speeding up editing

If you press and hold the **INC** key, then also hold the **DEC** key, the value will increase faster. If you press and hold the **DEC** key then also hold the **INC** key, the value will decrease faster.

Storing Set-ups

The set-ups can be stored in non-volatile memory. To do this, press & hold the **SELECT** button (for approx. 6 seconds) till the display reads 'st'.

PARAMETERS

Below is a list of parameters available to edit. The letters in square brackets show (where applicable) what will be displayed in the parameter 7-segment LED.

Menu

number **Parameter (default)**

0 **MIDI receive channel (default: 1)**

Range 1 to 16 (and off)
- Sets the MIDI receive channel.

1 **MIDI transmit channel (default: 2)**

Range 1 to 16 (and off)
- Sets the MIDI transmit channel.

2 **AUX controller number (default: 16)**

- Sets which MIDI controller will control the auxiliary output.

The following can be selected;

Off	[Of]
Pitch bend	[Pb]
Velocity	[VL]
Aftertouch	[Af]
MIDI controllers	0-120

3 **AUX minimum value (default: 0)**

Range 0 to 127
Sets the level for the Auxiliary output when the MIDI controller source is at its minimum. 10 units correspond to approximately 1 volt.
N.B. - the aux minimum can be set above the max, in which case the controller will work in reverse

4 **AUX maximum value (default: 90)**

Range 0 to 127
- Sets the level for the Auxiliary output when the MIDI controller source is at its maximum.

5 AUX reset value (default: 0)

Range 0 to 127

- Sets the level the Auxiliary output will reset to when the PRO DCB is powered up or receives a controller reset MIDI command.

6 LFO to AUX controller (default: 1)

- Sets which Controller will control the LFO depth applied to the auxiliary.

The following can be selected;

Off	[Of]
Pitch bend	[Pb]
Velocity	[VL]
Aftertouch	[Af]
MIDI controllers	0-120

7 LFO speed (default: 90)









Range 0 to 127

- Sets the speed of the LFO. This can also be adjusted in real time over MIDI using controller #18 (general purpose controller #3)

NB - when the unit is receiving MIDI sync, the LFO speed will be directly related to the MIDI clock rate and the divide ratio. The window will then say SY until either the speed is edited or the unit is powered on again. If the unit stops receiving MIDI sync, the LFO will continue to run at the same speed as when the sync stopped.

8 LFO waveshape (default: TR)

- Sets the LFO waveshape. All waveshapes modulate Aux any value between 0 to a positive value, except triangle, which modulates positive and negative. The waveshapes can be changed in real time over MIDI using controller #19 (general purpose controller #4). The following may be selected; (arrow indicates trigger point for MIDI sync).

Triangle	[TR]		Sawtooth up	[SU]	
Sawtooth down	[SD]		PulseWidth 10%	[10]	
PulseWidth 20%	[20]		PulseWidth 30%	[30]	
PulseWidth 40%	[40]		Square	[50]	
Sample + Hold (actually a new S/H level for each trigger)	[SH]		(Pseudo random)		

9 LFO MIDI SYNC (default: off)

Range off [of] and 1 to 48)

Use with caution – leave this setting at OFF unless you specifically require it. Settings of 4 to 48 are usable settings, lower values, although not restricted, should only be used with low BPM settings.

This allows the LFO waveform to be synchronised to MIDI clock, with a variable divide ratio. The LFO waveform will automatically adjust its length so that it fits almost exactly between MIDI clocks, and last for what ever musical time it is set for (see below for divide ratios).

A divide ratio can be set so the LFO only retriggers every so many MIDI clock messages. If set to 1, there will be 1 cycle of the LFO for every 1 MIDI clock. (i.e. 24 cycles per quarter note). If set to 24, there will be 1 cycle of the LFO for every 24 MIDI clocks. (i.e. 1 cycle of the LFO per quarter note)
Note: MIDI sends 24 clocks per quarter note.

Below is a table of values you can set the divide ratio to to obtain LFO cycles of various musical lengths:

Note type;	Divide ratio;	Max BPM to use;
Minim	48	240
Crotchets	24	240
Crotchet triplets	16	240
Quavers	12	240
Quaver triplets	8	240
Semiquavers	6	240
Semiquaver triplets	4	240
Demisemiquavers	3	180
Demisemiquaver triplets	2	120
Every MIDI clock	1	60

a Juno/Jupiter Mode (default: Juno)

- Set this to receive optimum performance from your PRO-DCB depending on which synth you use. However if this is set-up incorrectly it will not cause any problems.

b Clock Divide Ratio (default: 2)

Range 1 to 24

- displays the ratio of MIDI clocks to output pulses from the arp clock jack socket.

If set to "2" there will be 1 pulse from the arp clock jack socket for every 2 MIDI clocks. (i.e. 12 pulses per quarter note). If set to "24" there will be 1 pulse from the arp clock jack socket for every 24 MIDI clocks. (i.e. 1 pulse per quarter note).

N.B. MIDI sends 24 clocks per quarter note.

C Positive / Negative edge clock pulse (default: Positive)

- sets whether the clock pulse train starts with a positive going edge or a negative going edge. Most synths / sequencers & drum machines will want the Positive edge pulse, (inc. Junos and Jupiters) but a few require the Negative edge instead. (e.g. Korg Monopoly).

D Continue = start - (values on, off, default = on)

when set to off, MIDI continue messages are ignored. If set to on, then continue messages are treated as if they were MIDI start messages.

MIDI ANALYSER MODE

The *PRO DCB* also has a MIDI analyser function. This feature allows you to see what types of MIDI messages are being transmitted by your master keyboard/sequencer making the *PRO DCB* a useful diagnostic tool.

To enter analyser mode, you must power on the *PRO DCB* whilst holding the **SELECT** button. The display will then show 'nt'. 'nt' means the display will show the MIDI note number of any notes it receives.

Using the **INC**, **DEC**, and **SELECT** buttons, different types of MIDI messages received may be displayed;

SELECT	Short press	[rC] Receive channel
	Long press	[PC] Program change
DEC	Short press	[nt] Note number
	Long press	[nv] Velocity
INC	Short press	[Cn] Controller number
	Long press	[Cv] Controller value

For whichever of the above selected, the *PRO DCB* will display the value it receives for the message selected.

Although pitchbend and after-touch are not controllers, when Controller number is selected, 'pb' will be displayed if pitchbend is received, & 'af' will be displayed if after-touch is received.

If Controller values is selected, and pitchbend or after-touch are received, their values will be displayed.

For values over 99 the usual method is employed for displaying large numbers.

The MENU 7-segment LED in this mode operates as a received MIDI message indicator. LED's will flash when then following types of messages are received; Note on, Note off, Sysex, Timing clock (MIDI clock), Start, Stop, Continue.

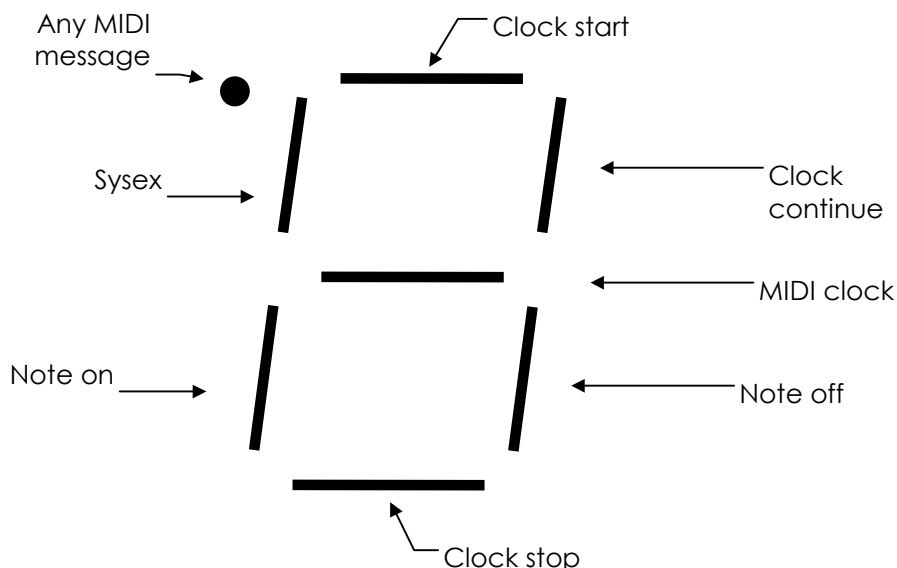

To exit MIDI analyser mode, the *PRO DCB* must be powered off then on again.

USING YOUR PRO-DCB AS A DCB-MIDI CONVERTER

Your *PRO-DCB* is bi-directional, ie. it can also be used to effectively turn your Juno or Jupiter into a master keyboard so that when you play the Juno/Jupiter itself, the notes will appear at the MIDI out. In fact due to the way that DCB works, when you play your MIDI master keyboard - the Juno/Jupiter will echo the notes played straight to the MIDI out. As a result of this it is possible to play a chord on either the master keyboard or the Juno/Jupiter - and if the arpeggiator is on, the arpeggiated notes will appear, in sync, at the MIDI out (dependant on the arpeggiator being MIDI synced of course).

The Juno and Jupiter synths, do not have velocity sensitive keyboards, nor does the DCB protocol support velocity. So you will not get velocity when using the *PRO-DCB* - however the aux output can be set to respond to velocity, in which case the velocity from your MIDI or master keyboard can be used to control the VCF on a Juno, or VCF/VCA on a Jupiter 8. When a chord is played the Aux will take the level of the highest velocity note currently being played.

The DCB cable which is supplied will work in this mode without any change being necessary. However, you will obviously have to plug the MIDI out from the *PRO-DCB* into the MIDI IN of your sequencer or other MIDI keyboard. Filter and arpeggio controls are one way only (i.e. this information can only be sent to the Juno).

PROBLEMS YOU MAY ENCOUNTER WHEN USING MIDI CLOCK

When using MIDI clock in conjunction with the *PRO-SOLO*, please note the following.

First, ensure that the *PRO-SOLO* is actually receiving MIDI clock. This is not as silly as it sounds - there are a number of reasons why it may not be receiving MIDI clock messages in the first place. If you are having problems, go into the MIDI analyser mode described on page 13 and see if the *PRO-SOLO* is actually receiving the MIDI clock messages. If the *PRO-SOLO* is not receiving clock messages, here are a few points to watch for:-

Some MIDI mergers & patch bays actually remove MIDI clock information from the data stream, or you may have to enable it for the port you are using.

Users of CUBASE note that the default for MIDI clock is for it NOT to be sent, you will have to go into the MIDI synchronisation page and select MIDI clock to transmit.

Users of UNITOR/EXPORT on an Atari note that the MIDI clock will only come out of port A, (that is the Atari's own MIDI port), unless you can re-assign it.

USING YOUR PRO-DCB WITH A JUNO 6

The Roland Juno 6 while operating in a similar way to the 60, is not usually equipped with a DCB port. However here at KENTON we can fit one, or sell a kit for you to do it yourself. It will then operate in exactly the same way as the Juno 60. Contact us here at KENTON for more details.

PIN-OUT DETAILS OF SUPPLIED DCB CABLE

CONVERTER END

The PRO DCB is supplied with a cable which will connect it to all Juno's and some Jupiter 8's. The pin outs of this cable at the converter end are as follows:

n.b. the receive and transmit wires must be separately screened from each other.

8 pin plug (viewed from terminals).

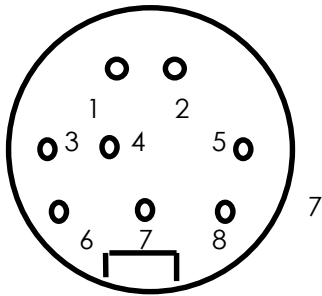

- | | |
|---|---------------------------|
| 1 | Busy (transmit to Juno) |
| 2 | Data (transmit to Juno) |
| 3 | Clock (transmit to Juno) |
| 4 | Common Ground |
| 5 | Busy (receive from Juno) |
| 6 | Data (receive from Juno) |
| 7 | Clock (receive from Juno) |
| 8 | No connection |

SYNTHESIZER END

Juno 60 (and some Jupiter 8s) connector
14 way IEEE plug (viewed from terminals).

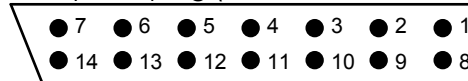

- | | |
|--------------------|------------------------|
| PIN 1 - Busy (rx) | PIN 2 - Data (rx) |
| PIN 3 - Clock (rx) | PIN 4 - Ground(common) |
| PIN 5 - Busy (tx) | PIN 6 - Data (tx) |
| PIN 7 - Clock (tx) | |

No other pins connected. Insulate the screen at this end.

USING YOUR *PRO-DCB* WITH NON-STANDARD JUPITER 8'S

Some Jupiter 8's are fitted with 20 pin sockets rather than the standard 14 pin version included with your *PRO-DCB*. These are available from us here at Kenton, alternatively it is possible to make your own, wiring is as follows. Note that Kenton cannot be held responsible for any problems caused by leads not supplied by us.

Other Jupiter 8s connectors

20 pin bump polarised socket (viewed from terminals).

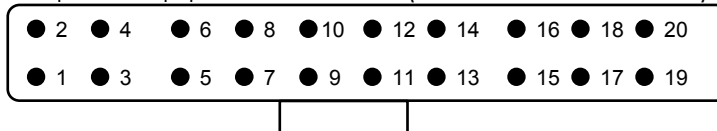

- | | |
|-------------------|--------------------|
| PIN 1 - Clock(tx) | PIN 3 - Data (tx) |
| PIN 5 - Busy (tx) | PIN 7 - Clock (rx) |
| PIN 9 - Data (rx) | PIN 10 - Ground |
| | PIN 11 - Busy (rx) |

CONTROLLER NUMBERS

Controller Number		Control Function
Decimal	Hex	
0	00H	Bank switch MSB
1	01H	Modulation wheel/lever
2	02H	Breath controller
3	03H	Undefined
4	04H	Foot controller
5	05H	Portamento time
6	06H	Data entry MSB
7	07H	Main volume
8	08H	Balance
9	09H	Undefined
10	0AH	Pan
11	0BH	Expression controller
12-15	0C-0FH	Undefined
16-19	10-13H	General purpose controllers (1-4)
20-31	14-1FH	Undefined
32-63	20-3FH	LSB for values 0-31
64	40H	Damper pedal (sustain)
65	41H	Portamento
66	42H	Sostenuto
67	43H	Soft pedal
68	44H	Undefined
69	45H	Hold 2
70-79	46-4FH	Undefined
80-83	50-53H	General purpose controllers (5-8)
84-90	54-5AH	Undefined
91	5BH	External effects depth
92	5CH	Tremolo depth
93	5DH	Chorus depth
94	5EH	Celeste (detune) depth
95	5FH	Phaser depth
96	60H	Data increment
97	61H	Data decrement
98	62H	Non-registered parameter number LSB
99	63H	Non-registered parameter number MSB
100	64H	Registered parameter number LSB
101	65H	Registered parameter number MSB
102-120	66-78H	Undefined
121-127	79-7FH	Reserved for channel mode messages

RESETTING THE PRO DCB TO FACTORY DEFAULTS

Turning the *PRO DCB* on whilst holding down all three push buttons will return the unit's settings to default values. `Fd` will momentarily be displayed when this has been done.

DISPLAYING THE SOFTWARE VERSION

Power on the *PRO DCB* whilst holding the INC and DEC buttons pressed and the software revision [43xx] and build number [0xxx] will be displayed. Releasing the buttons will revert to the normal operational mode.

SPECIFICATIONS

Power Input	9V DC (unregulated or regulated supply required)	
Power	100mA, 2.1mm plug (centre positive)	
MIDI	In, Out, Thru	
Digital Input/output	DCB (In and Out)	
Analogue outputs	Clock	(0-5v)
	Aux	(0-12.5v)
Weight	600g	
Dimensions	167 x 97 x 40 mm	
Non-volatile memory	EEPROM (no back-up battery required)	

WARRANTY

The *PRO DCB* comes with a 12 month (from purchase date) back to base warranty, (i.e. customer must arrange and pay for carriage to and from Kenton Electronics).

KENTON

KentonElectronics Limited

Brookfarm House, Station Road, South Wimbledon, London, SW19 2LP, UK

Tel: +44 (0)20 8544 9200

Fax: +44 (0)20 8544 9300

e-mail : sales@kenton.co.uk

web : www.kenton.co.uk

rev# 3145 e. & o. e.

© 19th March 2012